

BNC 50 Ohm Straight Crimp Type Plug - Solder or Crimp Contact - 3 Piece

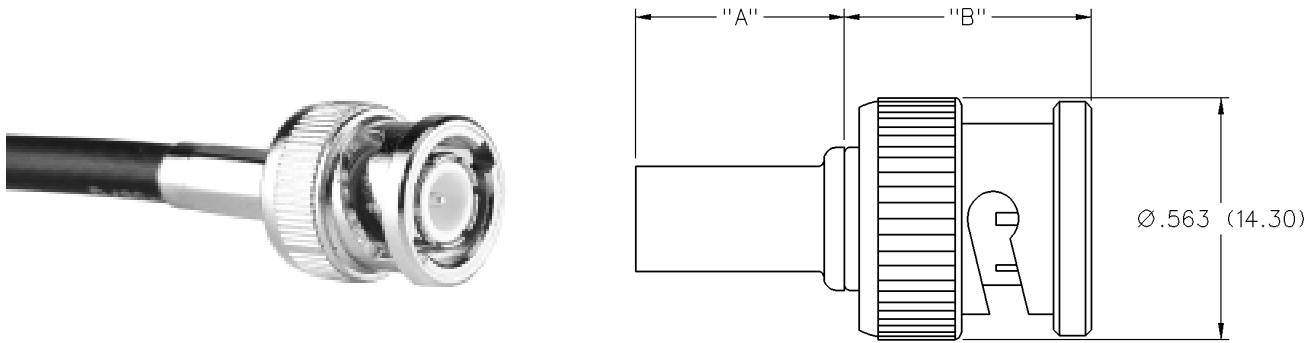

INCHES (MILLIMETERS)
CUSTOMER DRAWINGS AVAILABLE UPON REQUEST



PART NUMBER	CABLE TYPE	"A"	"B"	CONTACT I.D.	BODY I.D.	FERRULE I.D.
CPMC-88-18	BELDEN 8218	.520 (13.20)	.595 (15.11)	.0245 (0.62)	.107 (2.72)	.175 (4.45)

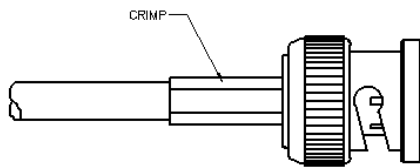
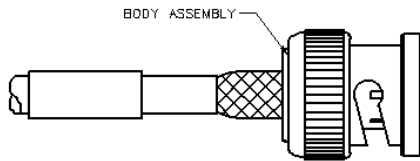
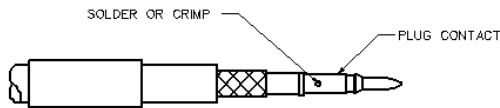
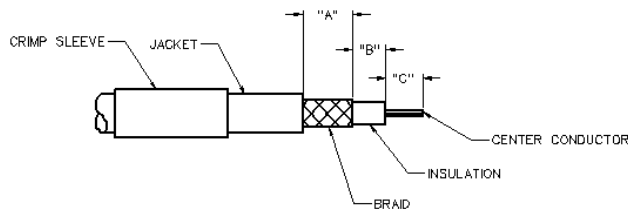
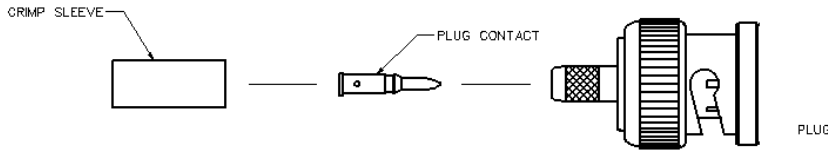

1. Identify connector parts. (3 piece parts)
2. Strip cable to dimensions shown. Do not nick braid or center conductor. Tin center conductor if contact will be solder attached. Do not tin center conductor if contact is to be crimp attached. A wire stripper of correct size is recommended for this step. Slide heat shrink (as applicable) and crimp sleeve onto jacket of cable.
3. Assemble contact onto cable as shown.
Solder Attachment: Solder contact to center conductor through hole using a minimum amount of solder for a good joint.
Crimp Attachment (where applicable): Crimp contact to center conductor using recommended crimp hex.
4. Flare braid and slide body assembly over contact and under braid. Then seat body assembly firmly onto contact. The cable may have to be held in a clamping fixture. Arrange braid uniformly around crimp stem. Slide crimp sleeve forward and crimp using recommended crimp hex. Slide heat shrink forward and shrink (as applicable).

Part Number	Cable	Strip Dimensions			Crimp Sleeve Hex	Contact Crimp Hex	Recommended Crimp Hex
		"A"	"B"	"C"			
CPMC-88-18	BELDEN 8218	.315 (8.00)	.118 (3.00)	.157 (4.00)	.184 (4.67)	.060 (1.52)	24-306P

BNC Connectors

Specifications



INCHES (MILLIMETERS)
CUSTOMER DRAWINGS AVAILABLE UPON REQUEST

The BNC series connector is a commercial quality product that intermates with all standard double bayonet stud BNC designs. All contacts are captivated for ruggedness. The 50 ohm and 75 ohm interfaces are intermateable and provide quick, reliable connections for instrumentation, medical and LAN applications.

Specifications*

50 Ohm BNC

Electrical Characteristics

Impedance: 50 Ohm nominal

Frequency range: 0-4 GHz

Working voltage: 500 volts RMS at sea level

Dielectric withstanding voltage: 1500 volts RMS at sea level

Corona level: 375 volts minimum at 70,000 feet

Contact resistance: Outer - 0.2 milliohms maximum

Center - 2.1 milliohms maximum

Insulation resistance: 5000 megohms minimum

Environmental Characteristics

Recommended temperature range: -55°C to +85°C

Moisture resistance: MIL-STD-202

Mechanical Characteristics

Durability: 500 cycles

Force to engage/disengage: 3 lbs. maximum

Cable retention: 20 lbs., RG-58 C/U cable

Materials

Body: Zinc or brass

Contact: Brass, beryllium copper or phosphor bronze

Spring Washer: Beryllium copper

Crimp sleeve: Brass

Insulator: Delrin® or TPX Polymethylpentene

Plating: Body - Nickel (except where noted)

Crimp sleeve - Nickel

Contact - Gold

* These values are typical and may not apply to all connectors.